



40 TON SHOP PRESS

SAFETY INSTRUCTIONS MANUAL



1 GENERAL

- Operator and Supervisor Information
- Signal Word Definition
- Safety Considerations for Shop Press Operation
- Signal Word Panel

2 SHOP PRESS SIGNAL WORD PANEL

3 SIGNAL WORDS

- Danger Panel
- Warning Panel
- Caution Panel
- Notice Panel

OPERATOR AND SUPERVISOR INFORMATION

This is one of four manuals supplied with your machine.

- Installation Manual
- Safety Instructions Manual
- Operations Manual
- Maintenance Manual

All rights reserved. Reproduction of this manual in any form, in whole or in part, is not permitted without the written consent of Edwards Manufacturing Company.

Do not resell, relocate or export to a destination other than to the original point of sale. Edwards has designed this machine to meet the standards of the original receiving country and is not liable for meeting any governing body or performance standards beyond those of the original receiving country.

READ ALL MANUALS BEFORE OPERATING MACHINERY. Operating machinery before reading and understanding the contents of all four manuals greatly increases the risk of injury.

Each of the four machine manuals describes 'best practices' in handling, installing, operating and maintaining your machine. The contents of each manual is subject to change without notice due to improvements in the machinery or changes in National or International standards.

Keep all manuals close to the machine to allow for easy reference when necessary.

SAFETY CONSIDERATIONS FOR SHOP PRESS OPERATION

Your Shop Press has the capacity and force to pinch, crush, cut and form metal. These same attributes can pinch, crush and cut body parts that are within the point of operation (P.O.O.). During machinery operation keep all body parts clear of the P.O.O.

Provide operators with sufficient training and education in the basic functions of the machine prior to machine operation.

Do not allow for operation of the machine by unqualified or untrained personnel. Edwards Manufacturing is not liable for accidents arising from unskilled, untrained operation.

This machine is manufactured for use by able bodied and able minded operators only. Never operate machinery when tired or under the influence of drugs or alcohol.

Never leave a powered machine unattended. **Turn machinery OFF** before walking away.

Do not modify or change the machine without written authorization from Edwards manufacturing Company. Unauthorized modification to a machine may result in serious operator injury, machine damage and will void your warranty.

Edwards Machinery has been designed to comply with applicable National /International Standards.

Edwards Manufacturing Co. suggests that Owners and Operators of this machinery become familiar with the shared responsibility of the machinery manufacturer and user in providing for the safe use of the machinery as

referenced in the applicable National/International standards. Additional safety information may be available by consulting your insurance providers risk management / loss prevention program.

Physical guards provide the most effective means of employee protection. Guards and awareness barriers are provided on the Machinery where practical. Due to the universal nature of shop press operation and daily manufacturing constraints, physical guarding at the point of operation (P.O.O.) has not been provided by the manufacturer of this equipment.

Additional safeguarding, particularly at the P.O.O. is considered job specific and is solely the responsibility of the Owner/User/Operator of the machine (ANSI B11.3-2012 4.2). Utilize ANSI Risk Assessment strategies to determine the most appropriate, user provided P.O.O. safeguarding method for the forming task at hand.

SIGNAL WORD DEFINITION



Indicates a hazardous situation that, if not avoided, will result in death or serious injury.



Indicates a hazardous situation that, if not avoided, could result in death or serious injury.



Indicates a hazardous situation that, if not avoided, could result in mild or moderate injury.



Indicates information considered important, but not hazard related.

SIGNAL WORD PANEL ON MACHINE



Critical machine safety information is identified on signal word labels. Labels are attached adjacent to the potentially hazardous locations of the machine. Reference the Safety Instruction Manual for additional information regarding the potentially hazardous condition identified on the label.

Review ALL labels on the machinery, reference the operational precautions and safe operations sections within this manual before any operation activity is initiated.

Failure to read and understand the signal word labels affixed to the machinery may result in operator death or injury.

 **WARNING:** This product can expose you to chemicals including Methyl Isobutyl Ketone which is known to the State of California to cause cancer and birth defects or other reproductive harm. For more information go to <http://www.p65warnings.ca.gov>.

 **WARNING:** Some dust, fumes and gases created by power sanding, sawing, grinding, drilling, welding and other construction activities contain chemicals known to the State of California to cause cancer and birth defects or other reproductive harm. Some examples of these chemicals are:



- lead from lead based paint
- crystalline silica from bricks, cement and other masonry products
- arsenic and chromium from chemically treated lumber

Your risk of exposure varies, depending on how often you do this type of work. To reduce your exposure to these chemicals, work in a well-ventilated area and work with approved safety equipment, such as dust masks that are specifically designed to filter out microscopic particles. For more information go to <http://www.p65warnings.ca.gov/> and <http://www.p65warnings.ca.gov/wood>.



SHOP PRESS • SIGNAL WORD PANEL





DANGER

-  Hydraulic accessory controls powered by Ironworker / Porta-Power.
-  Lockout power at Ironworker / Porta-Power before servicing.







WARNING

-  Shear/Crush Hazard. Moving parts can cut and crush.
-  Fluid injection Hazard. Hydraulic fluid is under pressure. Hydraulic fluid powers moving parts.
-  Keep guards in place.

CAUTION

-  Press Adjustment. Exercise caution when adjusting the height of the Shop Press.
-  Cylinder Adjustment. Exercise caution when adjusting the rolling cylinder.

NOTICE

-  Press Operations Are Dangerous. Exercise caution when installing, operating, and maintaining this machinery.
-  Read, understand, and follow all labels shown on the machine and described in the:
 - Installation Manual
 - Safety Manual
 - Operations Manual
 - Maintenance Manual
-  Keep all manuals close for easy reference.
-  Trained and authorized personnel are to install, operate and service this machinery. Do not allow for operation of the machine by unqualified personnel.
-  Personal protective equipment must be worn at all times during machinery operation.
-  Forklift Location. Do not attempt to lift the machinery by any other means.

NOTICE
 Must remove upper table pins before adjusting table height.

NOTICE

 Must remove upper table pins before adjusting table height.

DANGER PANEL

DANGER



Electrical Hazard

This is the electrical hazard symbol. It indicates there are dangerous high voltages present inside the enclosure of this product. **ONLY** qualified, authorized, maintenance, service or Certified Electricians should gain access to electrical panel.



Lockout Power

Danger circuits are live. Lockout / Tagout the upstream power source.

Lockout / Tagout machinery according to Employer procedures.

WARNING PANEL

WARNING



Shear/Crush Hazard

Moving parts can cut and crush. Keep hands clear while operating. Lockout power before servicing. Immediately replace guards after adjustment, repair or service.



Fluid Injection Hazard

Hydraulic hoses and cylinders are under pressure. Pressurized fluid can pierce skin and cause severe injury. To avoid physical hazard, always wear personal protective equipment. Keep hands clear while operating. Lockout power before servicing. Immediately replace guards after adjustment, repair or service.



Do Not Operate With Guard Removed

Physical barriers and guards have been designed and installed to protect the Operator from moving parts that can pinch, cut and crush. Keep hands clear while operating. Lockout power before servicing. Immediately replace guards after adjustment, repair or service to moving parts.

CAUTION PANEL

CAUTION



Hardened Pins for Height Adjustment

Exercise caution when adjusting the height of the Shop Press.



Added Caution Required

Exercise caution when adjusting the rolling cylinder.

NOTICE PANEL

NOTICE



Shop Press Operation

The Edwards Hydraulic 40 Ton Press is a 'do-all' tool capable of many functions. This manual outlines the basic functions associated with typical press operations and is neither intended to create a comprehensive list of, nor describe every operation possible with a press tool. **Press operations are dangerous and require extreme care and caution in the safe installation, operation and maintenance of the machinery. Edwards Manufacturing Company strongly suggests reading and understanding all manuals associated with the machinery as well as obtaining certified, technical, industrial machinery operations and maintenance training to reduce the risk of injury. Regardless of the contents of the machinery manuals Edwards Manufacturing Company will not be held liable for accidents caused by lack of training.**



Refer to All Manuals

Each manual that comes with this machine contains critical instructions regarding proper operations, safety, installation and maintenance procedures. Understand the contents of each manual thoroughly. Failure to follow proper procedures may result in serious operator injury, machine damage and will void your machine warranty. Keep the manuals close to the machine for easy reference.



Wear Personal Protective Equipment

To avoid physical hazard, always wear personal protective equipment. Wear protective eyewear, clothing, gloves, footwear, head-gear and hearing protection while operating or servicing this machinery.



Forklift Location

This machine is equipped with rated forklift movement points. Do not attempt to lift the machinery by any other means. Inappropriate movement of the machinery may result in serious operator injury, machine damage and will void machine warranty. Consult the installation manual for equipment weight ratings. Provide rated forklift and certified forklift operator to move machinery to appropriate location.

NOTICE



Table Pins

The table pins must be removed before attempting to adjust table height. Failure to do this can result in breaking of the lift chains and potential injury to operator.



IRONWORKERS

1107 SYKES ST., ALBERT LEA, MN 56007 800-373-8206 WWW.EDWARDSIRONWORKERS.COM



40 TON SHOP PRESS

INSTALLATION MANUAL



1 GENERAL

- Operator and Supervisor Information
- Signal Word Definition
- Signal Word Panel

2 INSTALLING THE SHOP PRESS

- Environmental Requirements at Work Station
- Receiving the Shop Press
- Unpacking/Moving the Shop Press
- Installing the 40 Ton Shop Press

4 HYDRAULIC POWER

- Powering with an Edwards Ironworker
- Powering with an Edwards Porta Power

OPERATOR AND SUPERVISOR INFORMATION

This is one of four manuals supplied with your machine.

- **Installation Manual**
- **Safety Instructions Manual**
- **Operations Manual**
- **Maintenance Manual**

READ ALL MANUALS BEFORE OPERATING MACHINERY. Operating machinery before reading and understanding the contents of all four manuals greatly increases the risk of injury.

Each of the four machine manuals describes 'best practices' in handling, installing, operating and maintaining your machine. The contents of each manual is subject to change without notice due to improvements in the machinery or changes in National or International standards.

All rights reserved. Reproduction of this manual in any form, in whole or in part, is not permitted without the written consent of Edwards Manufacturing Company.

Keep all manuals close to the machine to allow for easy reference when necessary.

Provide operators with sufficient training and education in the basic functions of the machine prior to machine operation.

Do not allow for operation of the machine by unqualified personnel. Edwards Manufacturing Company is not liable for accidents arising from unskilled, untrained operation.

Do not modify or change the machine without written authorization from Edwards Manufacturing Company. Unauthorized modification to a machine may result in serious operator injury, machine damage and will void your machine warranty.

Never leave a powered machine unattended. Turn machinery **OFF** before walking away.

This machine is manufactured for use by able bodied and able minded operators only. Never operate machinery when tired or under the influence of drugs or alcohol.

Do not resell, relocate or export to a destination other than to the original point of sale. Edwards has designed this machine to meet the standards of the original receiving country and is not liable for meeting any governing body or performance standards beyond those of the original receiving country.

SIGNAL WORD DEFINITION

DANGER

Indicates a hazardous situation that, if not avoided, will result in death or serious injury.

WARNING

Indicates a hazardous situation that, if not avoided, could result in death or serious injury.

CAUTION

Indicates a hazardous situation that, if not avoided, could result in mild or moderate injury.

NOTICE

Indicates information considered important, but not hazard related.



WARNING: This product can expose you to chemicals including Methyl Isobutyl Ketone which is known to the State of California to cause cancer and birth defects or other reproductive harm. For more information go to <http://www.p65warnings.ca.gov>.



WARNING: Some dust, fumes and gases created by power sanding, sawing, grinding, drilling, welding and other construction activities contain chemicals known to the State of California to cause cancer and birth defects or other reproductive harm. Some examples of these chemicals are:

- lead from lead based paint
- crystalline silica from bricks, cement and other masonry products
- arsenic and chromium from chemically treated lumber

Your risk of exposure varies, depending on how often you do this type of work. To reduce your exposure to these chemicals, work in a well-ventilated area and work with approved safety equipment, such as dust masks that are specifically designed to filter out microscopic particles. For more information go to <http://www.p65warnings.ca.gov/> and <http://www.p65warnings.ca.gov/wood>.

SIGNAL WORD PANEL ON MACHINE

DANGER

Critical machine safety information is identified on signal word labels. Labels are attached adjacent to the potentially hazardous locations of the machine. Reference the Safety Instruction Manual for additional information regarding the potentially hazardous condition identified on the label.

Review ALL labels on the machinery, reference the operational precautions and safe operations sections within this manual before any operation activity is initiated.

Failure to read and understand the signal word labels affixed to the machinery may result in operator death or injury.

SHOP PRESS INSTALLATION

This manual provides installation requirements for the Edwards 40 Ton Shop Press.

All Edwards hydraulic accessory tools are powered by an Edwards Ironworker or an Edwards Porta Power, portable hydraulic power-plant.

Refer to Safety, Installation, Operations and Maintenance manuals for the Edwards power-plant you are using to operate your Edwards hydraulic accessory tool.

Environmental Requirements at Work Station

NOTICE

The work station environment for your Edwards Shop Press must meet the following minimum requirements:

- **Ambient temperature:** 7.2°C - 43.3°C [45°F - 110°F]
- **Relative humidity:** No greater than 90% relative humidity.
- **Floor area:** Assure that the machinery work area provides for a stable, adequately sized and load rated floor area for material movement to and from the machinery work stations.
- **Shelter:** Protect your Ironworking machinery from water, salts and corrosive elements.
- **Lighting:** 500LUX (50 footcandles) minimum.

Receiving the Shop Press

WARNING

Your Edwards 40 Ton Shop Press is fully assembled and has been shipped either by palletized custom wooden crate or by shrink-wrapped wooden pallet for ease of transport and receiving.

Inspect the packaging for damage and follow shipping/receiving instructions as listed on the packaging prior to receiving the tool into your facility.

When receiving your Hydraulic Accessory Tool, be prepared to safely move your machinery with a fork-lift rated for the following equipment weights:

Minimum Machinery Weight

40 Ton Press	612.34kg/1350lb
--------------	-----------------

Utilize best practices for fork-lift operation. Handle material as close to the drive surface as possible with the widest spread and deepest penetration of forks effective to service the pallet. Forks should be adjusted and locked into the safety detent closest to the maximum available fork spread.

Unpacking/Moving the Shop Press

Your Edwards 40 Ton Shop Press includes surface and remotely mounted electrical cabling and hydraulic lines. Exercise caution when removing the factory supplied packaging. Do not cut electrical wires or hydraulic hoses.

1. Carefully remove packaging.
2. Carefully remove the ¾" lagbolts and washers attaching the Press to the shipping pallet.
3. Locate the fork-lift areas directly adjacent to the cylinder.
4. Carefully insert forks under the press head assembly. Do not allow forks to hit cylinder or cylinder ram. Confirm that forks are in contact with both front and rear press head frames. Install clamps (not included) to forks so that the press is stable while moving and lift the press from the pallet.
5. Locate your Press directly adjacent to the Edwards Ironworker or Porta Power. **Ensure that power controls of the Ironworker or Porta Power are within arms-reach of the Press tool.**

Installing the 40 Ton Shop Press



1. The 40 Ton Shop Press is designed to mount on a dedicated, weight rated flooring system. **DO NOT MOUNT ON CASTERS.** The floor rating should be a minimum multiplier of 2.5 times the weight of the Press plus the weight of any tooling being used within the Press, plus the material being pressed.

**(Press weight (1350 lb.) + Tooling weight + Material weight)
x 2.5 = Dedicated, weight rated floor area**

2. Locate leveling and attachment brackets. With a level placed within the work cavity, check the machinery for level. Adjust for level by installing **four (4) ½" bolts** in the tapped holes provided in the brackets. When level, drill for **four (4) ¾" wedge anchor bolts** to secure press to floor. Install wedge anchor bolts, install washers, and tighten nuts to complete floor installation.

HYDRAULIC POWER SOURCES



Hydraulic Accessory Tool Power/Controls



Ironworker Hydraulic Accessory Package

WARNING

Your Edwards 40 Ton Shop Press is factory assembled and tested for optimum performance when powered by Edwards Manufacturing Company rated hydraulic power supply.

The Shop Press is powered by either an Edwards Ironworker factory installed Hydraulic Accessory Control Package or an Edwards Porta-Power, 5hp, 3000psi, portable power unit.

ALTERNATE POWER SOURCES ARE NOT RECOMMENDED AND MAY COMPROMISE MACHINE OPERATION, MACHINE HYDRAULIC WARRANTY AND OPERATOR SAFETY.

Follow electrical connection installation instructions for power supply as set forth within the Installation Manual of the Edwards Ironworker.

Powering with an Edwards Ironworker

Power selection controls are located adjacent to the starter box on the feed side of the machine. Hydraulic quick connections and accessory controls are located on the drop-off side or end cap of the machine.

With the Ironworker power off, install Shop Press hoses, power and control:

- Install the Shop Press male and female accessory hydraulic hoses to the ironworker male and female quick connect hydraulic fittings. Both fittings have a detent ball setting that must be aligned to couple and uncouple hoses.
- Remove the safety cap at the push button port. Attach the Shop Press male Mil. Spec. hand control cable to the female Mil. Spec. accessory control port at your Ironworkers Hydraulic Accessory package.

With all Ironworker and Press stations clear of hands, tools, tooling, material or debris, power up the Ironworker by depressing the green button on the starter box.

With the power on, your Ironworker machine will return to a neutral position.

Turn the 3-position switch on the front of the machine case to the Accessory position. This operation disables the Ironworker and switches control to the accessory hand control.

Test the Shop Press hand control operation by pressing the OUT control button. Once pressed, the hydraulic cylinder of the Shop Press will extend to operate the accessory. Releasing pressure on the OUT control button will stop the machine mid-operation. Return the tool to its starting position by depressing the IN button.

Press the red e-stop button to kill power at the Ironworker. To reset power, twist the e-stop button and push the start button at the ironworker.

When Disconnecting your Shop Press, simply reverse procedure. **Replace the safety cap at the push button port to restore power to your Ironworker.**



Powering with an Edwards Porta-Power

Your Edwards Porta-Power 5hp / 3000psi / Portable Power Unit will power all your Edwards Hydraulic Accessories.

Follow electrical connection installation instructions as set forth within these sections of the Porta-Power Installation Manual:

With the Edwards Porta-Power off, install accessory hoses, power and control:

- Install the male and female Shop Press hydraulic hoses to the Porta-Power male and female quick connect hydraulic fittings adjacent to the starterbox. Both fittings have a detent ball setting that must be aligned to couple and uncouple hoses.
- Remove the safety cap at the push button port. Attach the Shop Press male Mil. Spec. hand control cable to the female Mil. Spec. accessory control port on the Porta-Power case.

With all Press stations clear of hands, tools, tooling, material or debris, power up the Porta Power by depressing the green button on the starter box.

Test the Shop Press hand control operation by pressing the OUT control button. Once pressed, the hydraulic cylinder of the Shop Press will extend to operate the accessory. Releasing pressure on the OUT control button will stop the machine mid-operation. Return the tool to its starting position by depressing the IN button.

When disconnecting your Press, simply reverse procedure. **Replace the safety cap at the push button port to restore power to your Porta Power.**



IRONWORKERS

1107 SYKES ST., ALBERT LEA, MN 56007 800-373-8206 WWW.EDWARDSIRONWORKERS.COM



40 TON SHOP PRESS

OPERATIONS MANUAL

SERIAL NUMBER: _____



1 GENERAL

- Company Profile
- Warranty
- Machine Identification
- Operator and Supervisor Information
- Safety Considerations for Shop Press Operation
- Signal Word Definition
- Signal Word Panel
- Operational Precautions
- Machine Operations

4 HYDRAULIC POWER SOURCES

- Powering with an Edwards Ironworker
- Powering with an Edwards Porta-Power

6 OPERATIONS DIAGRAM

7 OPERATIONS

- Adjusting the Table
- Loading/Supporting/Securing Material
- Adjusting the Hydraulic Ram
- Safe Operation
- Press Operation

OPTIONAL TOOLING

- 9** Brake
- 11** Press Brake Tooling Set
- 13** Rod Shear/Multi-Shear
- 14** Pipe Notcher
- 15** Optional Foot Control Switch

17 TROUBLESHOOTING

COMPANY PROFILE



Edwards Manufacturing Company manufactures a full line of high quality, low maintenance hydraulic ironworking machines, associated tooling and accessories that are used in the steel fabrication industry. With proper operation, care, and maintenance, your Edwards Ironworker or Hydraulic Accessory

Tool will provide consistent, long-term service. Please take time to study this Operator's Manual carefully to fully understand Ironworker and Hydraulic Accessory Tool safety procedures, set-up, operation, care, maintenance, troubleshooting and warranty coverage prior to putting the machine into production. Any questions not answered within this manual can be directed to your local Edwards Ironworker dealer or factory representative.

Contact the factory:

EDWARDS MANUFACTURING COMPANY

1107 Sykes Street

Albert Lea, MN 56007

507 373 8206 PHONE

507 373 9433 FAX

www.edwardsironworkers.com

General Questions:

sales@edwardsmfg.us

Service Questions:

service@edwardsmfg.us

Contact your dealer:

WARRANTY

Edwards Manufacturing Company will, within one (1) year of date of original purchase (proof of purchase required), replace F.O.B. the factory, any goods, excluding punches, dies and shear blades, which are defective in materials or workmanship provided that the buyer return the defective goods, freight pre-paid, to the seller, which shall be the buyer's sole and exclusive remedy for the defective goods. Hydraulic components are subject to their manufacturer's warranty.

Edwards Manufacturing Company will, within thirty (30) days of date of original purchase (proof of purchase required), replace F.O.B. the factory, any punches, dies and/or shear blades, which are defective in materials or workmanship.

This warranty does not apply to machines and/or components which have been altered, changed or modified in any way, or subjected to abusive and abnormal use, inadequate maintenance and lubrication, or subjected to use beyond seller recommended capacities and specifications. Edwards Manufacturing Company shall not be liable for labor costs expended on such goods or consequential damages. Edwards Manufacturing Company shall not be liable to the purchaser or any other person for loss, down-time, or damage directly or indirectly arising from the use of the goods or from any other cause. No officer, employee, or agent of Edwards Manufacturing Company is authorized to make any oral representations or warranty of fitness or to waive any of the foregoing terms and none shall be binding on Edwards Manufacturing Company.

NOTE: Edwards Manufacturing is a division of JPW Industries, Inc. References in this document to Edwards also apply to JPW Industries, Inc., or any of its successors in interest to the Edwards brand.

MACHINE IDENTIFICATION

Your Edwards Shop Press has been serialized for quality control, product traceability and warranty enforcement. Please refer to the aluminum identification tag with engraved serial number, electrical and power specifications when ordering parts or filing a warranty claim.

OPERATOR AND SUPERVISOR INFORMATION

This is one of four manuals supplied with your machine.

- Installation Manual
- Safety Instructions Manual
- Operations Manual
- Maintenance Manual

All rights reserved. Reproduction of this manual in any form, in whole or in part, is not permitted without the written consent of Edwards Manufacturing Company.

Do not resell, relocate or export to a destination other than to the original point of sale. Edwards has designed this machine to meet the standards of the original receiving country and is not liable for meeting any governing body or performance standards beyond those of the original receiving country.

READ ALL MANUALS BEFORE OPERATING MACHINERY. Operating machinery before reading and understanding the contents of all four manuals greatly increases the risk of injury.

Each of the four machine manuals describes 'best practices' in handling, installing, operating and maintaining your machine. The contents of each manual is subject to change without notice due to improvements in the machinery or changes in National or International standards.

Keep all manuals close to the machine to allow for easy reference when necessary.

SAFETY CONSIDERATIONS FOR SHOP PRESS OPERATION

Your Shop Press has the capacity and force to pinch, crush, cut and form metal. These same attributes can pinch, crush and cut body parts that are within the point of operation (P.O.O.). During machinery operation keep all body parts clear of the P.O.O.

Provide operators with sufficient training and education in the basic functions of the machine prior to machine operation.

Do not allow for operation of the machine by unqualified or untrained personnel. Edwards Manufacturing is not liable for accidents arising from unskilled, untrained operation.

This machine is manufactured for use by able bodied and able minded operators only. Never operate machinery when tired or under the influence of drugs or alcohol.

Never leave a powered machine unattended. **Turn machinery OFF** before walking away.

Do not modify or change the machine without written authorization from Edwards manufacturing Company. Unauthorized modification to a machine may result in serious operator injury, machine damage and will void your warranty.

Edwards Machinery has been designed to comply with applicable National /International Standards.

Edwards Manufacturing Co. suggests that Owners and Operators of this machinery become familiar with the shared responsibility of the machinery manufacturer and user in providing for the safe use of the machinery. Additional safety information may be available by consulting your insurance providers risk management / loss prevention program.

Physical guards provide the most effective means of employee protection. Guards and awareness barriers are provided on the Machinery where practical. Due to the universal nature of shop press operation and daily manufacturing constraints, physical guarding at the point of operation (P.O.O.) has not been provided by the manufacturer of this equipment.

Additional safeguarding, particularly at the P.O.O. is considered job specific and is solely the responsibility of the Owner/User/Operator of the machine (ANSI B11.3-2012 4.2). Utilize ANSI Risk Assessment strategies to determine the most appropriate, user provided P.O.O. safeguarding method for the forming task at hand.

SIGNAL WORD DEFINITION

 **DANGER**

Indicates a hazardous situation that, if not avoided, will result in death or serious injury.

 **WARNING**

Indicates a hazardous situation that, if not avoided, could result in death or serious injury.

 **CAUTION**

Indicates a hazardous situation that, if not avoided, could result in mild or moderate injury.

NOTICE

Indicates information considered important, but not hazard related.

SIGNAL WORD PANEL ON MACHINE

 **DANGER**

Critical machine safety information is identified on signal word labels. Labels are attached adjacent to the potentially hazardous locations of the machine. Reference the Safety Instruction Manual for additional information regarding the potentially hazardous condition identified on the label.

Review ALL labels on the machinery, reference the operational precautions and safe operations sections within this manual before any operation activity is initiated.

OPERATIONAL PRECAUTIONS

 **DANGER**

Reasonable, common sense safety precautions should be observed when operating the Ironworker or Hydraulic Accessory Tool. The following precautions are described in order of their hazard.

Electrical Hazard

Dangerous high voltages are present inside the electrical enclosure of this product. Only qualified, authorized, maintenance or service personnel should gain access to the electrical panel.

Lockout Power

Danger, circuits are live. Lockout / tagout upstream power source before any maintenance activity is performed.

Shear / Crush Hazard

Moving parts can cut and crush. Keep hands clear when operating and maintaining the Ironworker.

Hydraulic Fluid Hazard

Hydraulic hoses are under pressure. Pressurized fluid can pierce skin and cause severe injury. To avoid physical hazard, always wear personal protective equipment when operating and maintaining the Ironworker.

Do Not Remove Safeguarding

Physical barriers, guards, product safety signs and labels have been designed and installed to protect operators and maintenance personnel from moving parts that can pinch, cut and crush. If it is necessary to remove guarding when servicing the Shop Press, immediately replace safeguarding after service and prior to power being restored to the machinery.

Refer to Manuals

For safe installation, operation and maintenance of the machine, read:

- Installation Manual
- Safety Instructions Manual
- Operations Manual
- Maintenance Manual

Wear Personal Protective Equipment

To avoid physical hazard wear protective eyewear, clothing, gloves, footwear, head-gear and hearing protection.

MACHINE OPERATIONS



The Edwards Hydraulic 40 Ton Press is a 'do-all' tool capable of many functions. This manual outlines the basic functions associated with typical press operations and is neither intended to create a comprehensive list of, nor describe every operation possible with a press tool. **Press operations are dangerous and require extreme care and caution in the preparation of the material being worked, the press set-up and the pressing operation.**

Physical guards provide the most effective means of employee protection. Guards and awareness barriers are provided on the Shop Press where practical. Due to the universal nature of press brake forming and daily manufacturing constraints, physical guarding at the point of operation (P.O.O.) has not been provided by the manufacturer of this equipment.

Additional safeguarding, particularly at the P.O.O. is considered job specific and is solely the responsibility of the Owner/User/Operator of the machine (ANSI B11.3-2012 4.2). Utilize ANSI Risk Assessment strategies to determine the most appropriate, user provided P.O.O. safeguarding method for the forming task at hand.

Please refer to the following setup, safe operation and press operation sections for an understanding of the potential hazards present in any pressing operation.

The Edwards 40 Ton Press features a robust design and construction and is designed for years of heavy duty service when powered by an Edwards Ironworker or Porta Power portable hydraulic unit. Please refer to all Edwards power source manuals as well as the Safety, Installation, Operation and Maintenance Manuals of the 40 Ton Press prior to operation of the machinery.

The Press is constructed of four basic assemblies. The stationary rail assembly holds the stationary head assembly. The press bed assembly moves up and down the stationary rails and the hydraulic cylinder assembly rolls from side to side on the stationary head. Both the rolling cylinder assembly and moving press bed assembly are locked into place prior to any press operation.

The following pages detail the proper operations procedures for setting up and safely operating the Edwards 40 Ton Shop Press.



WARNING: This product can expose you to chemicals including Methyl Isobutyl Ketone which is known to the State of California to cause cancer and birth defects or other reproductive harm. For more information go to <http://www.p65warnings.ca.gov>.



WARNING: Some dust, fumes and gases created by power sanding, sawing, grinding, drilling, welding and other construction activities contain chemicals known to the State of California to cause cancer and birth defects or other reproductive harm. Some examples of these chemicals are:

- lead from lead based paint
- crystalline silica from bricks, cement and other masonry products
- arsenic and chromium from chemically treated lumber

Your risk of exposure varies, depending on how often you do this type of work. To reduce your exposure to these chemicals, work in a well-ventilated area and work with approved safety equipment, such as dust masks that are specifically designed to filter out microscopic particles. For more information go to <http://www.p65warnings.ca.gov/> and <http://www.p65warnings.ca.gov/wood>.

HYDRAULIC POWER SOURCES



Hydraulic Accessory Tool Power/Controls



Ironworker Hydraulic Accessory Package

WARNING

Your Edwards 40 Ton Shop Press is factory assembled and tested for optimum performance when powered by Edwards Manufacturing Company rated hydraulic power supply.

The Shop Press is powered by either an Edwards Ironworker factory installed Hydraulic Accessory Control Package or an Edwards Porta-Power, 5hp, 3000psi, portable power unit.

ALTERNATE POWER SOURCES ARE NOT RECOMMENDED AND MAY COMPROMISE MACHINE OPERATION, MACHINE HYDRAULIC WARRANTY AND OPERATOR SAFETY.

Follow electrical connection installation instructions for power supply as set forth within the Installation Manual of the Edwards Ironworker.

Powering with an Edwards Ironworker

Power selection controls are located adjacent to the starter box on the feed side of the machine. Hydraulic quick connections and accessory controls are located on the drop-off side or end cap of the machine.

With the Ironworker power off, install Shop Press hoses, power and control:

- Install the Shop Press male and female accessory hydraulic hoses to the ironworker male and female quick connect hydraulic fittings. Both fittings have a detent ball setting that must be aligned to couple and uncouple hoses.
- Remove the safety cap at the push button port. Attach the Shop Press male Mil. Spec. hand control cable to the female Mil. Spec. accessory control port at your Ironworkers Hydraulic Accessory package.

With all Ironworker and Press stations clear of hands, tools, tooling, material or debris, power up the Ironworker by depressing the green button on the starter box.

With the power on, your Ironworker machine will return to a neutral position.

Turn the 3-position switch on the front of the machine case to the Accessory position. This operation disables the Ironworker and switches control to the accessory hand control.

Test the Shop Press hand control operation by pressing the OUT control button. Once pressed, the hydraulic cylinder of the Shop Press will extend to operate the accessory. Releasing pressure on the OUT control button will stop the machine mid-operation. Return the tool to its starting position by depressing the IN button.

Press the red e-stop button to kill power at the Ironworker. To reset power, twist the e-stop button and push the start button at the ironworker.

When Disconnecting your Shop Press, simply reverse procedure. **Replace the safety cap at the push button port to restore power to your Ironworker.**



Powering with an Edwards Porta-Power

Your Edwards Porta-Power 5hp / 3000psi / Portable Power Unit will power all your Edwards Hydraulic Accessories.

Follow electrical connection installation instructions as set forth within these sections of the Porta-Power Installation Manual:

With the Edwards Porta-Power off, install accessory hoses, power and control:

- Install the male and female Shop Press hydraulic hoses to the Porta-Power male and female quick connect hydraulic fittings adjacent to the starterbox. Both fittings have a detent ball setting that must be aligned to couple and uncouple hoses.
- Remove the safety cap at the push button port. Attach the Shop Press male Mil. Spec. hand control cable to the female Mil. Spec. accessory control port on the Porta-Power case.

With all Press stations clear of hands, tools, tooling, material or debris, power up the Porta Power by depressing the green button on the starter box.

Test the Shop Press hand control operation by pressing the OUT control button. Once pressed, the hydraulic cylinder of the Shop Press will extend to operate the accessory. Releasing pressure on the OUT control button will stop the machine mid-operation. Return the tool to its starting position by depressing the IN button.

When disconnecting your Press, simply reverse procedure. **Replace the safety cap at the push button port to restore power to your Porta Power.**

OPERATIONS DIAGRAM

40 Ton Shop Press

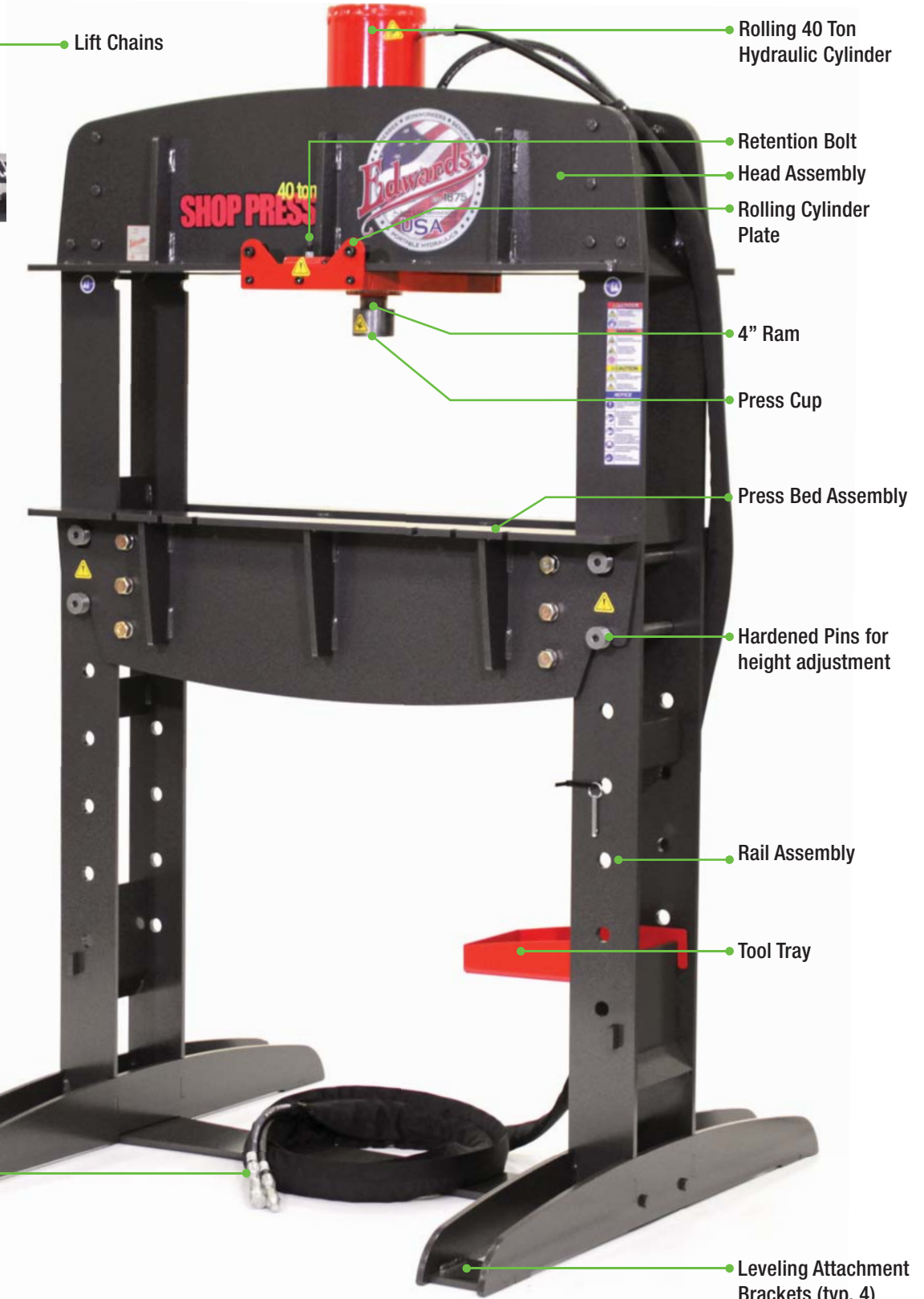
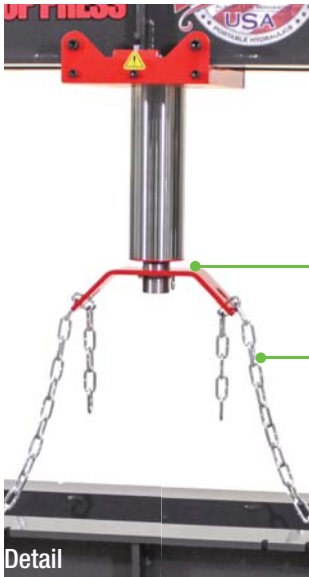

Hydraulic Hoses/
Control Cable

OPERATIONS

WARNING

Adjusting the Table

The press bed height adjusts in relation to the stationary elevation of the cylinder ram. **Do not attempt to manually lift or lower the press bed.** Utilize lift ring and lift chains to incrementally lift or lower the press bed to the appropriate working height for the material being pressed. **Locate table closest to work being performed to minimize ram extension under load.** Install the lift ring by removing the press cup at the ram end. Install the lift ring on the ram, lift beyond the 3/8" bore through the ram and secure with 3/8" grade 8 linchpin through ram. Identify the horizontal keyholes at both ends of the press bed assembly.

To raise the table, extend the ram and lift ring completely. Link the chains provided over the lift ring and drape chains through the keyholes in the press bed assembly. Make sure the chain links are equally distributed either side of the ram to the press bed keyholes. Engage chain into keyholes. Once secure, carefully raise the ram so that any slack is drawn out of the chains. Once tension is put on the chains, carefully remove the linchpins and hardened pins securing the press bed to the rail assembly. With the pins removed, carefully retract the cylinder to raise the press bed to the desired position. Insert hardened pins, re-install linchpins and remove lift chains and lift ring hardware to complete the press bed change.

To lower the table, retract the ram and lift ring to within 1/2" of complete retraction. Link the chains provided over the lift hooks and drape chains through the keyholes in the press bed assembly. Make sure the chain links are equally distributed either side of the ram to the press bed keyholes. Once secure, carefully raise the ram so that any slack is drawn out of the chains. Once tension is put on the chains, carefully remove the linchpins and hardened pins securing the press bed to the rail assembly. With the pins removed, carefully extend the cylinder to lower the press bed to the desired position. Insert hardened pins, re-install linchpins, and remove lift chains and lift ring hardware to complete the press bed change.

Loading / Supporting / Securing Material

Examine the material to be worked. Understand irregularly shaped materials and be prepared to adequately and safely support them through the pressing cycle. Utilizing best practices, carefully load the material into the working cavity of the press and support the material on the press bed. Utilize clamps or other security devices to hold the workpiece when practical. Consider the security and stability of the workpiece in the press cycle.

Shop Press Safeguarding

Physical guards provide the most effective means of employee protection. Guards and awareness barriers are provided on the Machinery where practical. Due to the universal nature of shop press operation and daily manufacturing constraints, physical guarding at the point of operation (P.O.O.) has not been provided by the manufacturer of this equipment.

Additional safeguarding, particularly at the P.O.O. is considered job specific and is solely the responsibility of the Owner/User/Operator of the machine (ANSI B11.3-2012 4.2). Utilize ANSI Risk Assessment strategies to determine the most appropriate, user provided P.O.O. safeguarding method for the forming task at hand.



- Center ram.
- Extend ram.
- Attach lift ring
- Insert pin into ram to hold lift ring in place.
- Attach lift chains to lift ring.
- Attach lift chains to press bed.



- Retract ram to tighten lift chains.
- Remove hardened pins.
- Retract ram to lift press head.



- Insert hardened pins at desired location.
- Replace cotter pins.
- Extend ram to relieve tension on chains.
- Remove chains and lifting hook.
- Install press cup.

OPERATIONS

Adjusting the Hydraulic Ram

The hydraulic ram is mounted to a rolling plate. The rolling feature allows for precision alignment for off-center pressing applications. Once aligned over the press site, carefully extend the ram to the press surface and fine-tune the ram alignment. Before starting the pressing operation, tighten the retention bolt at the rolling cylinder plate to secure the cylinder during the press operation.

Safe Operation



Observe the following guidelines when performing Press operations.

- **Operator Safety / Safe Work Zone** Applying pressure to parts or assemblies can cause failure of the part being worked, a part adjacent to the work or the pressing tool. Failed parts can become airborne projectiles with deadly force. Protect yourself with appropriate personal protective equipment and project specific safeguarding when operating the press. Protect others by defining a safe work zone for press use and limiting access to the press operator.
- **Press Inspection** Press operations may generate concussive failure to mechanical parts. Although Edwards press machinery is fabricated with both bolted and welded construction, concussive failure is a possibility over time or with extreme use. Prior to any press operation, visually check all bolted and welded connections for failure. All bolts must be tight and welds intact. Failure to verify the structural integrity of the machinery may result in workpiece shift, part ejection, operator injury or machinery damage.
- **Workpiece Inspection** Workpiece failure is the most common source of injury during press operations. Take time to thoroughly understand the workpiece. Never apply pressure to unstable objects, round shapes, balls, springs or any item with elastic, spring-back tendencies. Confirm the material properties of the workpiece will withstand the pressure to be exerted by the press. Confirm that workpiece items are stripped down to their simplest form. Many components contain unseen items that could fail during the press operation. Remove all sub components known to the workpiece prior to a pressing operation. Workpiece must be clean and free of substances at the pressing surface that would allow the pressing surfaces to slip under load.
- **Workpiece Support** Workpiece failure may be a result of improper or inadequate workpiece support. Adequate support for the workpiece must be present through the entirety of the press operation. Understand your workpiece and confirm that the workpiece support system you employ will withstand the pressure being exerted through the press operation.
- **Safe Use of Tooling** Edwards Manufacturing Company provides optional press tooling designed to provide for basic press applications. These tools are not designed to provide for all press applications. Care must be taken when selecting press tooling. Select tooling that is designed and rated for the specific application.
Press with the shortest, most compact, tool length available. Confirm that press tooling and workpiece are aligned and follows a direct press path. Misaligned loads may fail the press tooling or workpiece and cause operator injury or damage to the machinery.

- **Special Fits** Not all parts were designed or engineered to be removed or applied with a press. When inspecting your workpiece, confirm any press tolerances, environmental, heating, cooling or fixative requirements that require special care prior to initiating the press operation. Do not proceed with a press operation without acknowledgment that the workpiece is pressable.
- **Do Not Force Press** Consider the rating of the press and the work at hand. Gradually build pressure being applied to the workpiece. Carefully observe the workpiece to avoid tooling misalignment or workpiece failure. Observe the press as it reacts under load. Do not overload the press. Under heavy press operation built up force is released when the pressed part breaks free of its mount. This release of pressure is sudden and can appear to shake the machinery. Take care to avoid parts falling from the workpiece.

Press Operation

1. For Operator safety, wear personal protective equipment, clear the work zone of any tooling or debris prior to powering the machinery on.
2. Perform press inspection.
3. Perform workpiece inspection.
4. Turn power source on.
5. Retract ram, install press tooling.
6. Adjust press bed as necessary to achieve the shortest distance between the press ram and workpiece. Confirm hardened pins are fully engaged with linchpins secured.
7. Tighten retention bolts.
8. Safely load, position and support workpiece in press cavity.
9. Align and secure cylinder and ram over workpiece press site.
10. **Provide P.O.O. safeguarding method specific to pressing task at hand.**
11. Carefully, slowly, extend ram and tooling to meet press site. Preload the workpiece and observe workpiece support and tooling alignment. Observe the preloaded condition from multiple angles to assure that the press tooling is in alignment with the ram and workpiece. If unstable, reverse ram, reset workpiece and re-align press tooling.
12. Gradually build pressure to complete the press operation. Do not overload the press.
13. Retract the ram to relieve hydraulic pressure following the press operation.

OPTIONAL TOOLING - BRAKE



WARNING

Press Brake tooling ranging in size from 12" to 32" is available for the 40 Ton Shop Press. Brake tooling will allow for the graduated bending of 10 ga. x 32", 1/4" x 24", 3/8" x 6" flat stock up to 90 degrees.

Press brake tooling consists of a moving brake 'punch' and a stationary brake 'die'. The punch is held within a push block that is mounted upon two guide pin and spring assemblies fixed to the mounting plate. The die is held within two retaining brackets that are bolted to the mounting plate. Hydraulic force is applied to the push block assembly to activate the punch into the die assembly. Punches and dies are wearing parts and may need to be replaced over time. Contact your Edwards Dealer or the Factory for genuine Edwards replacement parts.

Setup

Turn off power to press by pressing the red stop/off button on the Edwards Ironworker or Edwards Porta-Power or lockout upstream power at the main electrical panel.

The press-brake tooling ships on a pallet. **This tooling is heavy and is supplied with fork-lift installation hardware for safe and easy setup.**

Install the brake tooling by unbolting the brake tooling from the shipping pallet and inserting fork-lift forks through the 4 brackets bolted to the brake mounting plate. Once the forks are stable in the brackets, apply clamps (not supplied) to the forks beyond the brake to prevent the brake from slipping off forks during installation.

Prepare the Press cavity to accept the brake tooling. Clean the press bed of any tooling or debris. Confirm that the press bed is secure, the hardened pins are properly seated and secured with their retaining clips.

Carefully lift the brake tooling with forklift and guide into the press cavity. Lower the brake tooling to the press bed and align through bolt holes in the press brake base table with the bolt slots in the press bed flanges. When aligned, carefully remove the safety clamps from the forks and remove the forks from the lifting brackets.

Secure the brake table to the press bed with 4pcs - 3/8" x 2" cap-screw, washer and nut assemblies (not supplied).

Remove the 4 mounting brackets. Re-install the mounting bolts.

The 4-way bottom die is marked for 1/16", 3/16", 1/8" and 1/4" flat stock. Select the correct bottom die surface according to the material being used. Observe brake and material tolerances as listed in the tooling specifications and at the tooling station.

Apply standard press cup to ram end, center ram over press-brake tooling and power machine on.

Jog ram down to press brake push block and center within the cup centering guide. Once aligned, secure rolling cylinder to head frame by tightening retention bolt.

Safe Operation

Observe the following guidelines when performing Press operations.

- **Operator Safety / Safe Work Zone** Applying pressure to parts or assemblies can cause failure of the part being worked, a part adjacent to the work or the pressing tool. Failed parts can become airborne projectiles with deadly force. **Protect yourself with appropriate personal protective equipment and project-specific safeguarding when operating the press. Protect others by defining a safe work zone for press use and limiting access to the press operator.**
- **Press Inspection** Press operations may generate concussive failure to mechanical parts. Although Edwards press machinery is fabricated with both bolted and welded construction, concussive failure is a possibility over time or with extreme use. Prior to any Press operation, visually check all bolted and welded connections for failure. All bolts must be tight and welds intact. Failure to verify the structural integrity of the machinery may result in workpiece shift, part ejection, operator injury or machinery damage.
- **Workpiece Inspection** Workpiece failure is the most common source of injury during press operations. Take time to thoroughly understand the workpiece. Never apply pressure to unstable objects, round shapes, balls, springs or any item with elastic, spring-back tendencies. Confirm the material properties of the workpiece will withstand the pressure to be exerted by the Press. Confirm that workpiece items are stripped down to their simplest form. Many components contain unseen items that could fail during the press operation. Remove all sub-components known to the workpiece prior to a pressing operation. Workpiece must be clean and free of substances at the pressing surface that would allow the pressing surfaces to slip under load.
- **Workpiece Support** Workpiece failure may be a result of improper or inadequate workpiece support. Adequate support for the workpiece must be present through the entirety of the Press operation. Understand your workpiece and confirm that the

workpiece support system you employ will withstand the pressure being exerted through the Press operation.

- **Safe Use of Tooling** Edwards Manufacturing Company provides optional press tooling designed to provide for basic Press applications. These tools are not designed to provide for all Press applications. Care must be taken when selecting Press tooling. Select tooling that is designed and rated for the specific application. **Press with the shortest, most compact, tool length available.** Confirm that Press tooling is aligned with workpiece and follows a direct press path. Misaligned loads may cause failure of Press tooling or workpiece and cause operator injury or damage to the machinery.
- **Special Fits** Not all parts were designed or engineered to be removed or applied with a press. When inspecting your workpiece, confirm any press tolerances, environmental, heating, cooling or fixative requirements that require special care prior to initiating the press operation. Do not proceed with a Press operation without acknowledgment that the workpiece is pressable.
- **Do Not Force Press** Consider the rating of the Press and the work at hand. Gradually build pressure being applied to the workpiece. Carefully observe the workpiece to avoid tooling misalignment or workpiece failure. Observe the Press as it reacts under load. Do not overload the Press. Under heavy press operation built up force is released when the pressed part breaks free of its mount. This release of pressure is sudden and can appear to shake the machinery. Take care to avoid parts falling from the workpiece.

Press Operation

1. For Operator safety, wear personal protective equipment, clear the work zone of any tooling or debris prior to powering the machinery on.
2. Perform Press inspection.
3. Perform workpiece inspection.
4. Turn power source on.
5. Retract ram, install press tooling.
6. Adjust Press bed as necessary to achieve the shortest distance between the press ram and workpiece. Confirm hardened pins are fully engaged with linchpins secured.
7. Tighten retention bolts.
8. Safely load, position and support workpiece in press cavity.
9. Align and secure cylinder and ram over workpiece press site.
10. Provide P.O.O. safeguarding method specific to pressing task at hand
11. Carefully, slowly, extend ram and tooling to meet press site. Preload the workpiece and observe workpiece support and tooling alignment. Observe the preloaded condition from multiple angles to assure that the Press tooling is in alignment with the ram and workpiece. If unstable, reverse ram, reset workpiece and re-align Press tooling.

12. Gradually build pressure to complete the Press operation. Do not overload the Press.

Retract the ram to relieve hydraulic pressure following the Press operation.

Brake Operation

1. Clear the Press Brake tooling station of any tools or debris prior to powering the machine on.
2. Confirm P.O.O. safeguarding measures are in place.
3. Turn your power source on and place the material to be "broken" on top of the bottom 4-way die.
4. **Center your material within the length of the bottom die.** Bending material 'off-center' to the ram may load the die unequally and produce poor quality parts, jam the push block on the guide pins and void the warranty on the tooling.
5. Position your material on the Brake die for the desired bend. Jog the 'punch' down to meet the material, **clear your hands from the working area** and depress the extend button on the hand control. Extend the ram to achieve your desired bend. When the operation is complete, retract the ram by pressing the retract button. Remove your material from the Press Brake tooling when the ram has fully retracted from the tooling and the tooling has returned to its neutral position.

OPTIONAL TOOLING - PRESS BRAKE TOOLING SET

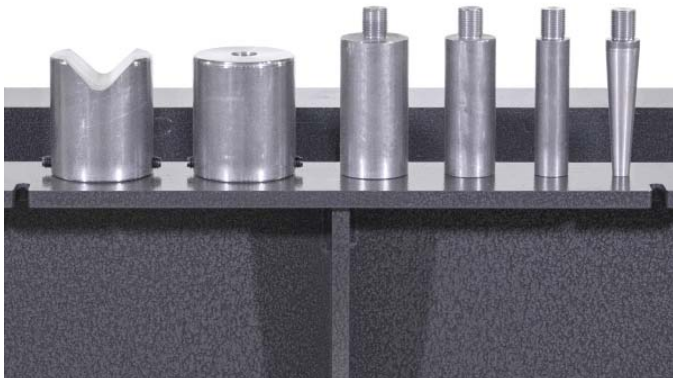

WARNING

Edwards Manufacturing Company provides optional press tooling designed to provide for basic press applications.

The Press Brake Tooling Set includes:

- 1 ea. 3" dia. x 3 1/2" V-Cup
- 1 ea. 3" dia. x 3 1/2" Threaded Cup
- 1 ea. 2" dia. x 4" Threaded Shaft
- 1 ea. 1 1/2" dia. x 4" Threaded Shaft
- 1 ea. 1" dia. x 4" Threaded Shaft
- 1 ea. 1" dia. x 4" Tapered Shaft

These tools are not designed to provide for all press applications. Choose your tooling according to the Operations section of this manual.

Press operations are dangerous and require extreme care and caution in the preparation of the material being worked, the press set-up and the pressing operation. Please refer to the following setup, safe operation and press operation sections for an understanding of potential hazards present in any pressing operation.

Setup

Turn off power to press by pressing the red stop/off button on the Edwards Ironworker or Edwards Porta-Power or lockout up-stream power at the main electrical panel.

Your Shop Press was shipped with a standard press cup. A press cup protects the ram end of the cylinder during pressing operations. **NEVER PRESS DIRECTLY WITH CYLINDER RAM END. PRESSING WITH EXPOSED RAM END MAY DAMAGE THE MACHINED SURFACE, SCRATCH THE RAM AND DAMAGE THE CYLINDER AND VOID THE MANUFACTURER'S WARRANTY.**

Remove the standard press cup by relieving the ball-detent screws in the cup face. If utilizing the V – Cup press end, install by slipping the cup end over the ram end of the cylinder. Tighten the ball-detent screws in the V-Cup so that the cup fully engages the machined groove in the cylinder ram.

If utilizing the threaded or tapered shaft press tooling, note that this tooling threads into the 3" dia. x 3-1/2" Threaded Cup. Install threaded shaft ends into threaded cup and tighten so that the tooling is secure during the press operation. Once the threaded cup and threaded shaft are secure, install by slipping the cup end over the ram end of the cylinder. Tighten the ball-detent screws in the threaded-cup so that the cup fully engages the machined groove in the ram end of the cylinder.

Safe Operation

Observe the following guidelines when performing Press operations.

- **Operator Safety / Safe Work Zone** Applying pressure to parts or assemblies can cause failure of the part being worked, a part adjacent to the work or the pressing tool. Failed parts can become airborne projectiles with deadly force. **Protect yourself with appropriate personal protective equipment and project specific safeguarding when operating the press. Protect others by defining a safe work zone for press use and limiting access to the press operator.**
- **Press Inspection** Press operations may generate concussive failure to mechanical parts. Although Edwards press machinery is fabricated with both bolted and welded construction, concussive failure is a possibility over time or with extreme use. Prior to any Press operation, visually check all bolted and welded connections for failure. All bolts must be tight and welds intact. Failure to verify the structural integrity of the machinery may result in workpiece shift, part ejection, operator injury or machinery damage.
- **Workpiece Inspection** Workpiece failure is the most common source of injury during press operations. Take time to thoroughly understand the workpiece. Never apply pressure to unstable objects, round shapes, balls, springs or any item with elastic, spring-back tendencies. Confirm the material properties of the workpiece will withstand the pressure to be exerted by the Press. Confirm that workpiece items are stripped down to their simplest form. Many components contain unseen items that could fail during the press operation. Remove all sub-components known to the workpiece prior to a pressing operation. Workpiece must be clean and free of substances at the pressing surface that would allow the pressing surfaces to slip under load.
- **Workpiece Support** Workpiece failure may be a result of improper or inadequate workpiece support. Adequate support for the workpiece must be present through the entirety of the Press operation. Understand your workpiece and confirm that the workpiece support system you employ will withstand the pressure being exerted through the Press operation.

- **Safe Use of Tooling** Edwards Manufacturing Company provides optional press tooling designed to provide for basic Press applications. These tools are not designed to provide for all Press applications. Care must be taken when selecting Press tooling. Select tooling that is designed and rated for the specific application.
Press with the shortest, most compact, tool length available. Confirm that Press tooling is aligned with workpiece and follows a direct press path. Misaligned loads may fail the Press tooling or workpiece and cause operator injury or damage to the machinery.
 - **Special Fits** Not all parts were designed or engineered to be removed or applied with a press. When inspecting your workpiece, confirm any press tolerances, environmental, heating, cooling or fixative requirements that require special care prior to initiating the press operation. Do not proceed with a Press operation without acknowledgment that the workpiece is pressable.
 - **Do Not Force Press** Consider the rating of the Press and the work at hand. Gradually build pressure being applied to the workpiece. Carefully observe the workpiece to avoid tooling misalignment or workpiece failure. Observe the Press as it reacts under load. Do not overload the Press. Under heavy press operation built up force is released when the pressed part breaks free of its mount. This release of pressure is sudden and can appear to shake the machinery. Take care to avoid parts falling from the workpiece.
11. Carefully, slowly, extend ram and tooling to meet press site. Preload the workpiece and observe workpiece support and tooling alignment. Observe the preloaded condition from multiple angles to assure that the Press tooling is in alignment with the ram and workpiece. If unstable, reverse ram, reset workpiece and re-align Press tooling.
 12. Gradually build pressure to complete the Press operation. Do not overload the Press.
 13. Retract the ram to relieve hydraulic pressure following the Press operation.

Press Operation

1. For Operator safety, wear personal protective equipment, clear the work zone of any tooling or debris prior to powering the machinery on.
2. Perform Press inspection.
3. Perform workpiece inspection.
4. Turn power source on.
5. Retract ram, install press tooling.
6. Adjust Press bed as necessary to achieve the shortest distance between the press ram and workpiece. Confirm hardened pins are fully engaged with linchpins secured.
7. Tighten retention bolts.
8. Safely load, position and support workpiece in press cavity.
9. Align and secure cylinder and ram over workpiece press site.
10. Provide P.O.O. safeguarding method specific to pressing task at hand

OPTIONAL TOOLING - ROD SHEAR/MULTI-SHEAR



WARNING

“Bump-die” tooling is available for your Edwards Shop Press. Rod Shear or Multi Shear Tooling will provide distortion and burr free cuts to mild steel rod, square, bar and small angle stock as listed in the Ironworker Accessories specification.

Setup

“Bump-die” tooling and accessories fit within the Shop Press. Edwards “bump-die” tooling consists of a base plate, a housing which holds a stationary blade, a moving blade, return springs, and a push block. The moving ram of the Shop Press “bumps” the top moving blade to shear the material. If ordered as a factory installed option, your “bump-die” assembly is setup for immediate operation. If ordered as an option, the cavity of the machine must be cleared of any existing tooling, material or debris prior to tooling installation. To setup your Rod Shear or Multi Shear Tooling please observe the following steps.

Turn off power to press by pressing the red stop/off button on the Edwards Ironworker or Edwards Porta-Power or lockout upstream power at the main electrical panel.

Install the bump-die assembly:

1. Remove all tooling and debris from the press table.
2. Place the “bump-die” assembly on the press bed with the push block in line with the moving ram. Align bolt holes on base plate with slotted holes in press bed.
3. Secure the tooling to the press bed with four 1/2” bolts and washers (provided).
4. Check for push block and moving center alignment by powering on the machine and slowly inching down the ram to meet the push block. Power the machine off.

5. In the event that the push block and top die are not aligned, simply loosen the bolts under the table allowing the bump-die to be moved to center the push block with the moving center. When aligned, tighten the table bolts to secure the table.
6. Power the machine on and jog the ram down. The moving blade will close or bypass the fixed blade. The push block should not come in contact with the die housing.

Safe Operation

Observe the following guidelines when operating any Rod Shear or Multi-Shear bump-die tooling.

- Never exceed the capacities of the machine or tooling as described in the Ironworker specifications or listed at the tooling station.
- Keep the tooling clean.
- Check blade clearance and alignment at every tooling change, maintenance cycle or extended tooling operation. Maintain .010 clearance between blades at all times. Failure to maintain clearance will damage blades and support pockets.
- Do not stack cut material.
- Perform complete shearing operations only – partial cuts may jam the tooling and could result in breakage and operator injury.
- Use shearing aids when working with small items at the Rod Shear or Multi Shear Tooling station

Rod Shear/Multi-Shear Operation

1. Clear the work area of any tools or debris prior to powering the machine on.
2. Turn the Ironworker or Porta-Power on and insert material through the tooling guard and into the blade area. Position your material for the desired cut.
3. Clear your hands from the working area and press the extend button of the hand control to activate the tooling station.
4. When the cut is complete, press the retreat button of the hand control to automatically return the tooling to the neutral position.

OPTIONAL TOOLING - PIPE NOTCHER



Install the Pipe notcher Assembly:

1. Place the Pipe-Notcher assembly on the Shop Press support table with the bottom die pointing away from the machine.
2. Loosely secure the table from the underside of the base with four 1/2" bolts and washers (provided).
3. Check for push block and top die alignment by powering on the machine and slowly inching down the ram to meet the top die. Power the machine off.
4. In the event that the ram and top die are not aligned, simply loosen the bolts under the table allowing the table to be moved to center the push block centerline to the top blade. When aligned, tighten the table bolts to secure the table.
5. Power the machine on and jog the ram down. The pipe dies will close or bypass each other. The ram should not come in contact with the die housing.

Safe Operation

Observe the following guidelines when operating the Pipe Notch tooling.

- Never exceed the capacities of the machine or tooling as described in the Shop Press specifications or listed at the tooling station.
- Keep the Pipe Notcher tooling clean. When dirt or metal chips accumulate, remove 5/16-18 x 1/2" limit screw located in the center at the rear of punch. Lift out punch holder and two springs. Clean holder with solvent or kerosene.
- Check Pipe Notcher blade clearance and alignment at every tooling change, maintenance cycle or extended notcher operation. Maintain .010 clearance between notcher blades at all times. Failure to maintain clearance will damage blades and support pockets.
- Do not stack material to cut in the Pipe Notcher station.
- Perform complete notch operations only – partial notch cuts may jam the drop off side of the tooling and could result in breakage and operator injury.
- Use notching aids when working with small items at the notcher station.

Pipe Notcher Operation

1. Clear the feed table of the Pipe Notcher station of any tools or debris prior to powering the machine on.
2. Turn machine on. The top notcher die will be in the neutral position. Push the material into the blade area. Position your material to the desired cut.
3. Clear your hands from the working area and press the extend button on the hand control to activate the Pipe Notcher. When the operation is complete, return the top cutting die to its neutral position by pressing the retract button.

WARNING

Pipe-Notch tooling will provide a distortion and burr free, notch cut to mild steel pipe and tube stock. Common use of this tooling is in the fabrication of saddle connections for motorcycle and race car tube frames, tube fences etc. Please review the capacity labels listed in the Ironworker Accessories specifications as well as positioned at the Pipe-Notching Station.

Setup

Pipe Notch tooling installs within the working cavity of the Shop Press. Pipe Notch tooling for a shop press includes one top notcher die, one bottom notcher die and a die table. The top die is mounted within a spring loaded guide housing mounted to the die table. The bottom die attaches to the face of the guide housing and is machined with a saddle to aid in centering and guiding pipe sections into the die housing. The moving ram of the press cylinder pushes on the top blade to initiate the pipe notch. If ordered as a factory installed option, the pipe notcher assembly is set up for immediate operation. If ordered as an option, the open cavity of the press must be cleared of any existing tooling, material or debris prior to tooling installation. To set up your Pipe Notcher in an Edwards Shop Press, please observe the following steps.

Turn off power to press by pressing the red stop/off button on the Edwards Ironworker or Edwards Porta-Power or lockout upstream power at the main electrical panel.

Install the bump-die assembly:

1. Remove all tooling and debris from the press bed.
2. Place the bump-die tooling on the press bed and align base plate holes with press bed holes. Secure plate to press bed with 4pcs - 3/8" x 2" capscrew, washer and nut assemblies (not supplied).
3. Align rolling cylinder over center of tooling push block. Secure press cup to ram end, power machine on and jog ram down to tool. Confirm press cup alignment with tooling push block. Once aligned, secure rolling cylinder to head frame by tightening retention bolt.

OPTIONAL FOOT CONTROL SWITCH



WARNING

Your Edwards 40 Ton Shop Press is able to be controlled by an optional, three position “hold to run” foot control switch. This convenient plug and play control accessory is ideal for those that prefer to have their hands free during the operations cycle of the shop press.

This foot switch, along with “slow ram speed” and proper material handling techniques provide a level of safeguarding in accordance with the ANSI standard. When foot controls are used, a user based risk assessment is required to evaluate if additional safeguarding is necessary or required under the standards.

Setup

Turn off power to Shop Press by depressing the red stop/off button on the Edwards ironworker or Edwards Porta-Power or lockout upstream power at the main electrical panel.

Your Shop Press was shipped with a standard hand control / e-stop device. Remove the hand control by unscrewing the control cabling Mil Spec fitting at either your Edwards Ironworker or Edwards Porta Power hydraulic power source.

Attach the foot control switch male Mil Spec foot control cable to the female Mil Spec accessory control port (Push Button) at your Ironworker or Porta Power.

With all Ironworker and press stations clear of hands, tools, tooling, material or debris, power up the Ironworker or Porta Power by depressing the green button on the starter box.

If operating your accessory tool with an Ironworker, turn the 3-position switch on the front of the machine control panel to the Accessory position. This operation disables the Ironworker and switches control to the “hold to run” foot switch. This action is not required if operating the accessory with an Edwards Porta Power.

Test the Shop Press operation by pressing the foot control button. Once pressed, the hydraulic cylinder of the Shop Press will extend. Releasing pressure on the foot control switch will return the cylinder to its original, neutral position.

Depress the red e-stop button on the Ironworker or Porta Power to disable power to the Shop Press accessory tool. To reset power, twist the e-stop button and push the start button at the Ironworker or Porta Power.

When disconnecting your Shop Press, simply reverse procedure. Replace the safety cap at the push button port to restore power to your Ironworker. This action is not required if powering with an Edwards Porta Power.

Safe Operation

The 40 Ton Shop Press is powered by either your Edwards Ironworker or Edwards Porta Power, 3000psi portable hydraulic power source. The Edwards power source along with the Shop Press create a hydraulic accessory system. The 20' umbilical hosing and quick connect hardware deliver hydraulic power from the Edwards power source to the hydraulic cylinder within the frame of the Shop Press. The hydraulic cylinder applies pressure through a press cup to a part or assembly being worked.

Observe the following guidelines when performing Press operations.

- **Operator Safety / Safe Work Zone** Applying pressure to parts or assemblies can fail the part being worked, fail a part adjacent to the work or fail the pressing tool. Failed parts can become airborne projectiles with deadly force. **Protect yourself with appropriate personal protective equipment and project specific safeguarding when operating the press. Protect others by defining a safe work zone for press use and limiting access to the press operator.**
- **Press Inspection** Press operations may generate concussive failure to mechanical parts. Although Edwards press machinery is fabricated with both bolted and welded construction, concussive failure is a possibility over time or with extreme use. Prior to any Press operation, visually check all bolted and welded connections for failure. All bolts must be tight and welds intact. Failure to verify the structural integrity of the machinery may result in workpiece shift, part ejection, operator injury or machinery damage.
- **Workpiece Inspection** Workpiece failure is the most common source of injury during press operations. Take time to thoroughly understand the workpiece. Never apply pressure to unstable objects, round shapes, balls, springs or any item with elastic, spring-back tendencies. Confirm the material properties of the workpiece will withstand the pressure to be exerted by the Press. Confirm that workpiece items are stripped down to their simplest form. Many components contain unseen items that could fail during the press operation. Remove all sub-components known to the workpiece prior to a pressing operation. Workpiece must be clean and free of substances at the pressing surface that would allow the pressing surfaces to slip under load.
- **Workpiece Support** Workpiece failure may be a result of improper or inadequate workpiece support. Adequate support for the workpiece must be present through the entirety of the Press operation. Understand your workpiece and confirm that the workpiece support system you employ will withstand the pressure being exerted through the Press operation.

- **Safe Use of Tooling** *Edwards Manufacturing Company provides optional press tooling designed to provide for basic Press applications. These tools are not designed to provide for all Press applications. Care must be taken when selecting Press tooling. Select tooling that is designed and rated for the specific application. **Press with the shortest, most compact, tool length available.** Confirm that Press tooling is aligned with workpiece and follows a direct press path. Misaligned loads may cause failure of Press tooling or workpiece and cause operator injury or damage to the machinery.*
 - **Special Fits** *Not all parts were designed or engineered to be removed or applied with a press. When inspecting your workpiece, confirm any press tolerances, environmental, heating, cooling or fixative requirements that require special care prior to initiating the press operation. Do not proceed with a Press operation without acknowledgment that the workpiece is pressable.*
 - **Do Not Force Press** *Consider the rating of the Press and the work at hand. Gradually build pressure being applied to the workpiece. Carefully observe the workpiece to avoid tooling misalignment or workpiece failure. Observe the Press as it reacts under load. Do not overload the Press. Under heavy press operation built up force is released when the pressed part breaks free of its mount. This release of pressure is sudden and can appear to shake the machinery. Take care to avoid parts falling from the workpiece.*
12. *Gradually build pressure to complete the Press operation. Do not overload the Press.*
 13. *Retract the ram to relieve hydraulic pressure following the Press operation.*

Press Operation

1. *For Operator safety, wear personal protective equipment, clear the work zone of any tooling or debris prior to powering the machinery on.*
2. *Perform Press inspection.*
3. *Perform workpiece inspection.*
4. *Turn power source on.*
5. *Retract ram, install press tooling.*
6. *Adjust Press bed as necessary to achieve the shortest distance between the press ram and workpiece. Confirm hardened pins are fully engaged with linchpins secured.*
7. *Tighten retention bolts.*
8. *Safely load, position and support workpiece in press cavity.*
9. *Align and secure cylinder and ram over workpiece press site.*
10. **Provide P.O.O. safeguarding method specific to pressing task at hand**
11. *Carefully, slowly, extend ram and tooling to meet press site. Preload the workpiece and observe workpiece support and tooling alignment. Observe the preloaded condition from multiple angles to assure that the Press tooling is in alignment with the ram and workpiece. If unstable, reverse ram, reset workpiece and re-align Press tooling.*

TROUBLESHOOTING



WARNING

Quality parts are dependent upon conscientious setup, operation and maintenance of your Shop Press. Physically review your Shop Press prior to any operation. Confirm all static components are tight in the assembly. Confirm all moving components are free of obstruction. Confirm all tooling and assemblies are properly seated within the assembly.

Problem	Solution
Press Inoperable	Check accessory control switch Check shop press male 4-pin power cable is connected to female limit switch port. Note: Auto Cut port will NOT power the Shop Press accessory.
Rough cylinder operation	Check fluid level of machine. Check hoses for correct installation. Check fuse at transformer box.



IRONWORKERS

1107 SYKES ST., ALBERT LEA, MN 56007 800-373-8206 WWW.EDWARDSIRONWORKERS.COM



40 TON SHOP PRESS

MAINTENANCE MANUAL



1 GENERAL

Operator and Supervisor Information

Signal Word Definition

Signal Word Panel

Maintenance Precautions

2 MAINTENANCE SCHEDULE

Daily/Shift Change Visual Observation

General Maintenance - Daily

OPERATOR AND SUPERVISOR INFORMATION

This is one of four manuals supplied with your machine.

- **Installation Manual**
- **Safety Instructions Manual**
- **Operations Manual**
- **Maintenance Manual**

Each of the four machine manuals describes 'best practices' in handling, installing, operating and maintaining your machine. The contents of each manual is subject to change without notice due to improvements in the machinery or changes in National or International standards.

All rights reserved. Reproduction of this manual in any form, in whole or in part, is not permitted without the written consent of Edwards Manufacturing Company.

Understand the contents of each manual thoroughly. Keep all manuals close to the machine to allow for easy reference when necessary.

Provide operators with sufficient training and education in the basic functions of the machine prior to machine operation.

Do not allow for operation of the machine by unqualified personnel. Edwards Manufacturing Company is not liable for accidents arising from unskilled, untrained operation.

Do not modify or change the machine without written authorization from Edwards Manufacturing Company. Unauthorized modification to a machine may result in serious operator injury, machine damage and will void your machine warranty.

This machine is manufactured for use by able bodied and able minded operators only. Never operate machinery when tired or under the influence of drugs or alcohol.

Do not resell, relocate or export to a destination other than to the original point of sale. Edwards has designed this machine to meet the standards of the original receiving country and is not liable for meeting any governing body or performance standards beyond those of the original receiving country.

SIGNAL WORD DEFINITION

 **DANGER**

Indicates a hazardous situation that, if not avoided, will result in death or serious injury.

 **WARNING**

Indicates a hazardous situation that, if not avoided, could result in death or serious injury.

 **CAUTION**

Indicates a hazardous situation that, if not avoided, could result in mild or moderate injury.

NOTICE

Indicates information considered important, but not hazard related.

SIGNAL WORD PANEL ON MACHINE

 **DANGER**

Critical machine safety information is identified on signal word labels. Labels are attached adjacent to the potentially hazardous locations of the machine. Reference the Safety Instruction Manual for additional information regarding the potentially hazardous condition identified on the label.

Review ALL labels on the machinery, reference the operational precautions and safe operations sections within this manual before any operation activity is initiated.

Failure to read and understand the signal word labels affixed to the machinery may result in operator death or injury.

MAINTENANCE PRECAUTIONS

 **DANGER**

Reasonable, common sense safety precautions should be observed when maintaining the Ironworker or hydraulic accessory tool. The following precautions are described in order of their hazard. Your Shop Press is powered by an Ironworker or Porta Power as a component to the Hydraulic Accessory Tool system. Power isolation must be considered prior to commencement of any maintenance activities.

Electrical Hazard

Dangerous high voltages are present inside the electrical enclosure of this product. Only qualified, authorized, maintenance or service personnel should gain access to the electrical panel.

Lockout Power

Danger, circuits are live. Lockout / tagout upstream power source before any maintenance activity is performed.

Shear / Crush Hazard

Moving parts can cut and crush. Keep hands clear when servicing and maintaining the Shop Press.

Hydraulic Fluid Hazard

Hydraulic hoses are under pressure. Pressurized fluid can pierce skin and cause severe injury. To avoid physical hazard, always wear personal protective equipment when servicing / maintaining the Ironworker.

Do Not Operate With Guard Removed

Physical barriers and guards have been designed and installed to protect maintenance personnel from moving parts that can pinch, cut and crush. If it is necessary to remove guarding when servicing the Ironworker, immediately replace guards after service and prior to power being restored to the machinery.

Refer to Manuals

For safe installation, operation and maintenance of the machine, read:

- Installation Manual
- Safety Instructions Manual
- Operations Manual
- Maintenance Manual

Wear Personal Protective Equipment

To avoid physical hazard wear protective eyewear, clothing, gloves, footwear, head-gear and hearing protection.

 **WARNING:** This product can expose you to chemicals including Methyl Isobutyl Ketone which is known to the State of California to cause cancer and birth defects or other reproductive harm. For more information go to <http://www.p65warnings.ca.gov>.

 **WARNING:** Some dust, fumes and gases created by power sanding, sawing, grinding, drilling, welding and other construction activities contain chemicals known to the State of California to cause cancer and birth defects or other reproductive harm. Some examples of these chemicals are:

- lead from lead based paint
- crystalline silica from bricks, cement and other masonry products
- arsenic and chromium from chemically treated lumber

Your risk of exposure varies, depending on how often you do this type of work. To reduce your exposure to these chemicals, work in a well-ventilated area and work with approved safety equipment, such as dust masks that are specifically designed to filter out microscopic particles. For more information go to <http://www.p65warnings.ca.gov/> and <http://www.p65warnings.ca.gov/wood>.

MAINTENANCE SCHEDULE

CAUTION

Your Edwards Shop Press will benefit from reasonable care and periodic maintenance. Reasonable care includes daily visual observation, as well as general maintenance procedures at daily intervals by operator/maintenance personnel. Perform inspections and maintenance of the electrical, hydraulic, and mechanical systems of the Edwards hydraulic accessory connected to the Ironworker or Porta-Power as follows:

Daily/Shift Change Visual Observation

CAUTION

Electrical System

Visually inspect controls and power cording to the Ironworker or Porta-Power for signs of damage. Cut, abraded or crushed electrical cords may present an electrical hazard to the Operator and/or damage the machinery.

Hydraulic System

Visually inspect exposed or surface mounted hydraulic hoses and fittings for signs of damage. Cut, abraded or crushed hydraulic hoses or leaking fittings may present a hydraulic fluid hazard to the Operator and/or damage the machinery.

Mechanical System

Visually inspect moving parts. Guards and material hold-downs must remain on the machine for safe operation. Clear any material obstructions at the work station prior to visually inspecting moving parts of the machine. Cycle the machine. Machine should operate smoothly in hydraulic extend and retract mode.

Failure of any element of the daily/shift change visual observation will require maintenance of the affected accessory componentry. Please follow the following maintenance procedures.

General Maintenance - Daily

WARNING

Disconnect unit from power source.

Check wiring harness for loose connections or damaged control wiring.

Replace damaged control wiring as necessary. Order replacement control wiring assembly from your Edwards distributor or through Edwards Manufacturing Company.

Check hydraulic fittings and hoses for wear or damage. Replace damaged or worn hydraulic hoses and fittings as necessary. Order replacement hydraulic components from your Edwards distributor or through Edwards Manufacturing Company.

Check bolted connections and secure as necessary.

Check welded connections.

Check bearing surface quality.

Visually inspect press ram and wiper assemblies for chips or galling in the bearing surface.

Verify tooling is secure. Edwards tooling is manufactured from billet steel for enhanced strength and durability. These are wearing parts that will fail over time and will require replacement. Order additional tooling through your Edwards distributor or through Edwards Manufacturing Company. Install replacement parts according to the Operations Manual.

Clean your Press daily. Disconnect the unit from its power source first. Do not use liquid cleaners, aerosols, abrasive pads, scouring powders or solvents such as benzene or alcohol. Clean your machine with a brush and soft cloth lightly moistened with a mild, water-based detergent solution. Remove filings, dirt, dust and grime from working surfaces. Ensure the surfaces are fully dry before reconnecting power.



IRONWORKERS